

CULTIVATION

CHERVONETS

CHERVONETS XL

FLORIN

SHILLING

SANTIM



EQUIPMENT FOR CULTIVATION

Today, farmers place the highest demands on agricultural equipment, in particular on seedbed preparation units. At the same time, farmers aim to achieve maximum productivity per unit of time in addition to high-quality processing.

Modern farmers prefer multifunctional equipment that is capable to perform several soil preparation operations in one pass to reduce fuel consumption and soil compaction.



THE ONGOING OPERATION	CHERVONETS	CHERVONETS XL
Stubble cultivation	-	-
Pre-sowing preparation	+++	+++
Steam care	+	+
Inter-row processing	-	-
Use in a plowed field	+++	+++
Use in the field processed without formation turnover	-	+
Intensive mixing and crop residues incorporation	-	-
Plant nutrition	-	-

+++ optimally suitable

+ suitable

not suitable

LOZOVA MACHINERY cultivators are a range of high-quality and economical machines for various types of tillage, all types of soils and climatic conditions.

- CHERVONETS seedbed cultivators are designed to create an ideal sowing bed on a pre-plowed background without plant residues on the surface.
CHERVONETS XL seedbed cultivators are necessary to create a high-quality sowing bed on a pre-prepared background. Could be used with plant residues on the surface.
- FLORIN field cultivators are used for continuous pre-sowing cultivation, as well as for the cultivation of light stubble and weed control.
- SHILLING stubble cultivators are suitable for stubble cultivation to a depth of 7-15 cm with intensive mixing and incorporation of most of the plant residues into the soil. They are also ideal for use in a minimal cropping system.
- SANTIM inter-row cultivators are used for cultivation of tilled crops and vegetables. It is also equipped with mechanical weed control.

LOZOVA MACHINERY cultivators can be equipped with a system for applying liquid fertilizers and protective equipment with the most accurate dosing.



	FLORIN	SHILLING	SANTIM
	+	+++	-
	+++	+	-
	+++	+	-
	-	-	+++
	+++	+	-
	+++	+++	-
	-	+++	-
	-	-	+++

Seedbed preparation



CHERVONETS CHERVONETS XL

SEEDBED CULTIVATORS



TRADITIONAL
and ORGANIC

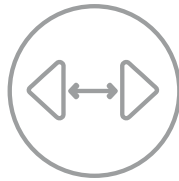

8 m
26' ft



min 150 hp



max 9 ha/h
max 22 acre/h

DESIGNED FOR PERFECT SEEDBED PREPARATION

Hardly any other implement can be such versatile as far as CHERVONETS allows to perform simultaneously:

- loosening the soil to a depth from 3 to 15 cm;
- incorporation of solid and liquid manure;
- second plowing and killing the weedage young crops;
- harrowing-out of the thread-like weeds;
- soil levelling.





Perfect seedbed preparation

Four rows of S-shaped spring tines with different working tools provide perfect soil tilling with further pulverization.



Loosened wheel tracks

CHERVONETS is equipped with track looseners, which can be adjusted depending on track height and width.



Perfect even surface

CHERVONETS has a spring-loaded multi-levelling bar for cost-effective levelling the soil in one pass. On medium and heavy soils the spring-loaded multi-levelling bar is set backward, to "grip". This compensates any unevenness in one pass. Springs protect the bar from damage. On light soil the bar is set forward, to "drag". Therefore, on level ground less soil piles in front of the bar, and the implement has a lower drag.

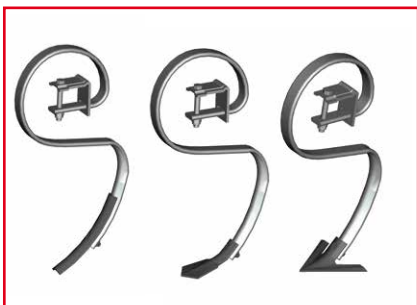

Working with different soil types

For working with different soil types the implement is supplied with three types of tools with working width from 35 mm to 150 mm. до 150 мм.

Working tools:

- wing sweep;
- duck foot;
- reversible chisel point.



CHERVONETS XL with module for applying liquid fertilizers

Presowing cultivators CHERVONETS XL can be equipped with an additional module for applying liquid fertilizers simultaneously with the main operation of the unit.

Large tank volume (3000 l) and precise dosing system ensure ideal plant nutrition.



Blockage-free roller

The roller has no central axle, thus there is no roller blockage even in overwatered conditions.

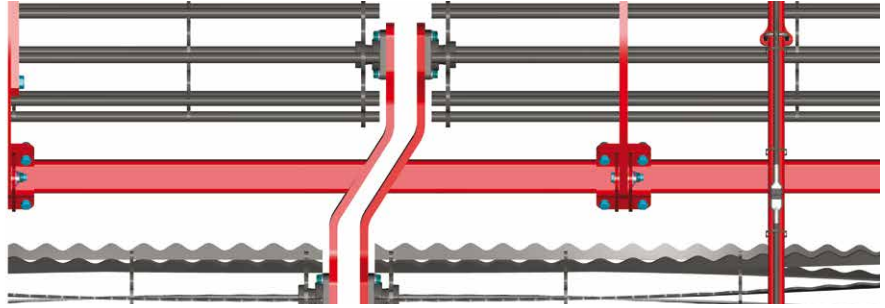

Rollers mating without gaps

Front and rear rollers have different diameters and rotation speeds, providing the finer soil fraction.

Doubled balance roller provides constant soil compacting with both rollers independently of ground contours. There are no gaps at the rollers joint.

TECHNICAL DATA

	CHERVONETS	CHERVONETS XL
Working width, m; ft	8 /26'	8 /26'
Tractor power, hp	min 150	min 150
Coupling with tractor	semi-trailed	semi-trailed
Basic weight, kg; lbs	3850-3950/8487-8708	4000/8818
Number of tines, pcs	65	45
Operating depth, cm; inch	3-15/1"-6"	3-15/1"-6"
Operating speed, km/h; mph	10-15/6-9	10-15/6-9
Efficiency, ha/h; acre/h	max 9/22 acre/h	max 9/22 acre/h
Fuel consumption, l/ha; gal/ac	max 6/0.6	max 6/0.6
Transport dimensions (length x width x height), mm; inch	5955x3000x4000 234"x 118"x 157"	5955x3000x4000 234"x 118"x 157"

Seedbed preparation



FLORIN

MULTIPURPOSE FIELD CULTIVATOR



TRADITIONAL
and ORGANIC

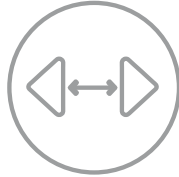

8 m
26' ft



min 200 hp



max 9 ha/h
max 22 acre/h

Field cultivator FLORIN is used for continuous pre-sowing soil cultivation, cultivation of light stubble and weed control.

The cultivator allows you to prepare the seedbed at a precisely defined depth and perfectly seals moisture.



FLEXIBLE APPROACH TO THE UNIT PACKAGE FOR EACH SPECIFIC FARM

THREE OPTIONS OF TINES

You can choose one of the possible set of parts depending on required works, specific field conditions and tasks, which makes it possible to perfectly prepare the seedbed and get high yields in the season..



PACKING ROLLER

Optional mounting of a double-row tooth spring harrow and packing roller in any combination.

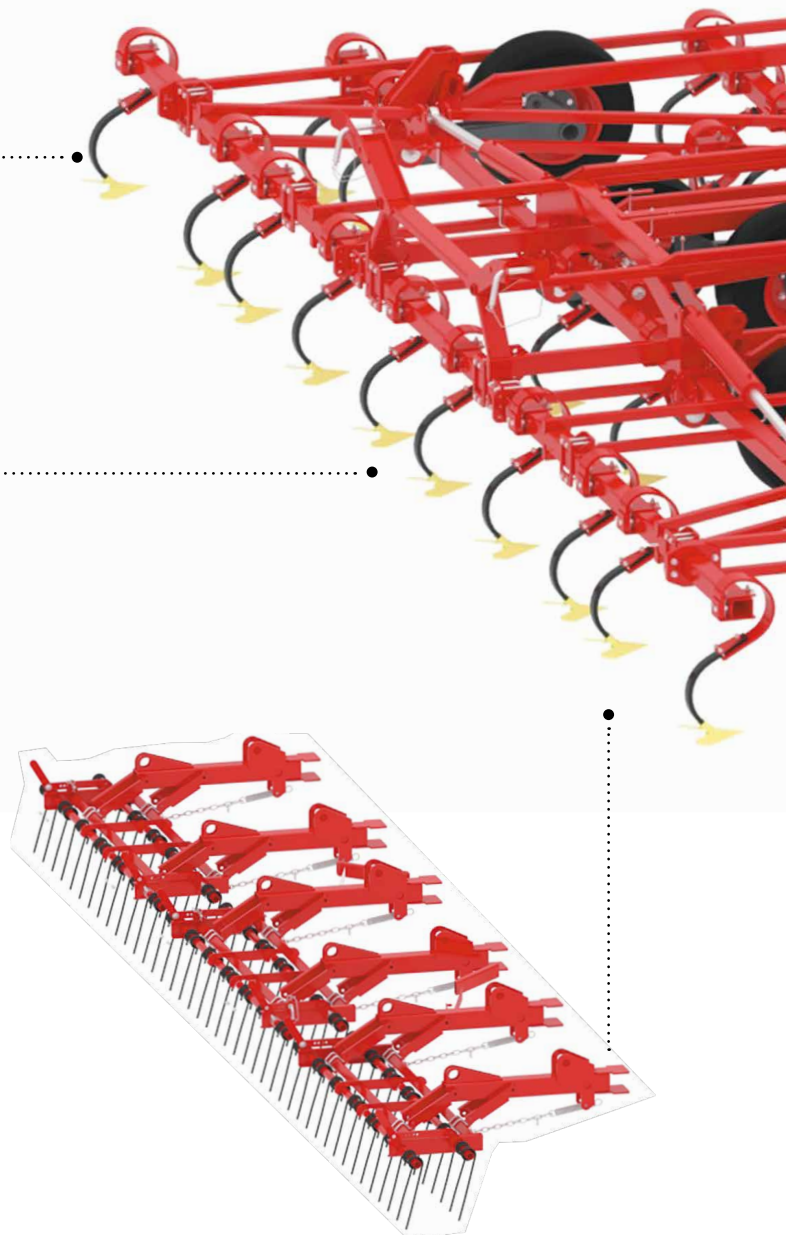

TOOTH SPRING HARROW

The teeth on two rows make the field even and uniform, evenly distributing soil and crop residues, destructing weeds.

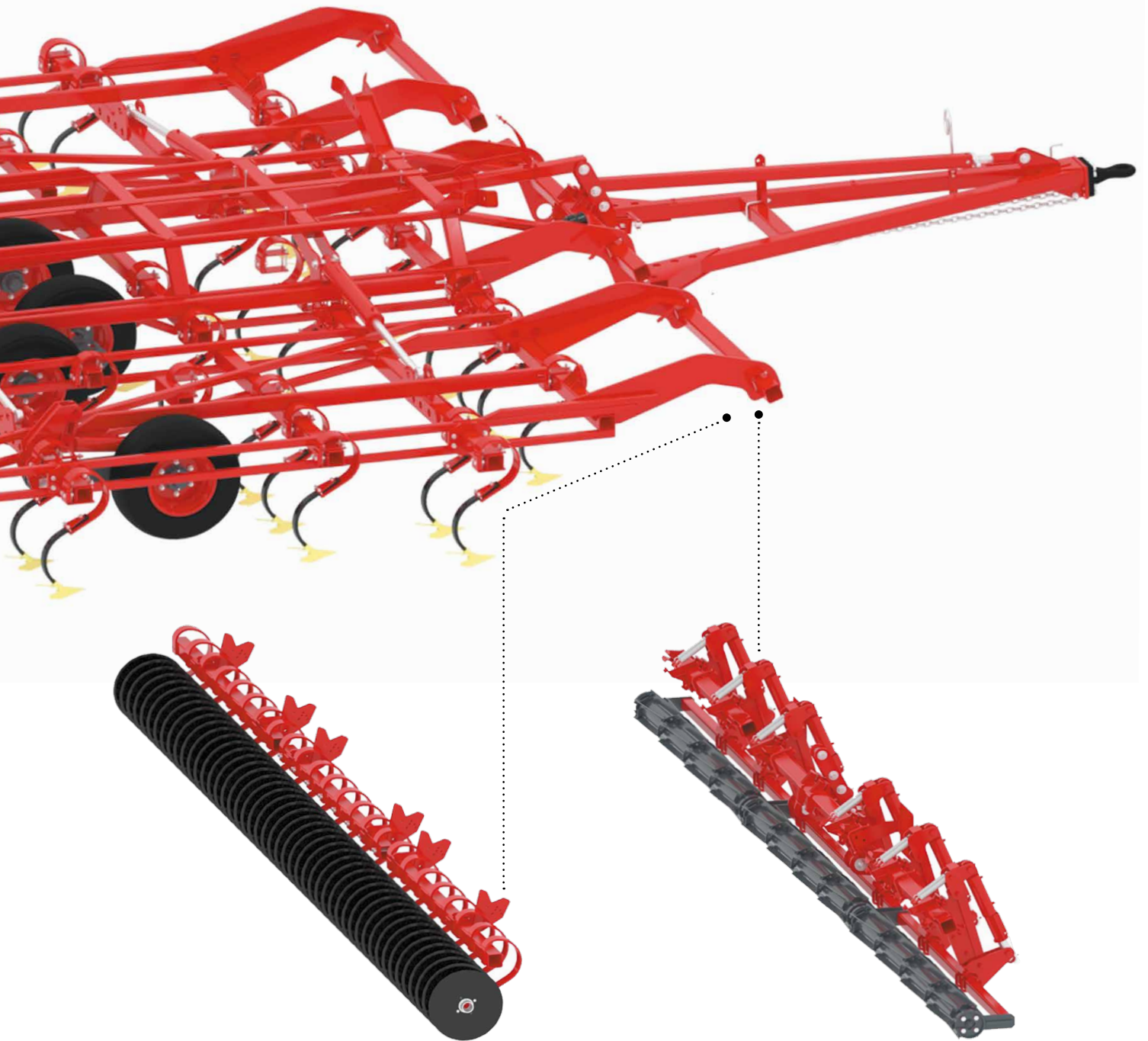

FRONT CUTTING DISCS

The implement can be additionally equipped with front cutting discs for reliable operation on stubbles without clogging and cultivation of big amount of crop residues without their accumulation.

FRONT CHOPPING ROLLER

It is possible to mount chopping roller in addition to the front cutting discs.



Unique frame

One of the longest frames in its class is designed for operation without clogging. Soil, crop residues and chemicals are evenly mixed and distributed over the entire width of the unit and the depth of soil cultivation.

The distance between the rows of racks is 850 mm.

The distance between the first and last row of tines is 4150 mm.



Three options of tines

There are three options of tines:

- spring tine with cross section 30 x30
- spring-loaded tine of variable cross-section, which reduces resistance and power consumption
- spring damper.



Packing roller, tooth harrow

The original design of the roller does not have a central axis, so the roller is not clogged even in wet soil and foul field conditions.

The spring tooth is made of high-quality stainless steel with a special double heat treatment.

The resource of LOZOVA MACHINERY tooth is three times higher than that of other manufacturers.

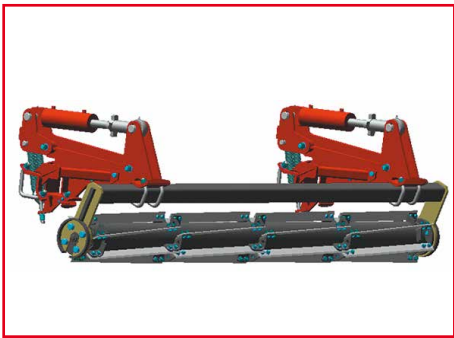

Possibility of working on stubble

Chopping roller is used for pre-crushing of stubble has blades made of boron steel for super-floatation on the stubble.



Additional cutting discs

The edge of each cutting turbo-disc enters the soil perpendicularly to the surface, providing the best longitudinal crushing of stubble.



Cultivation depth adjustment

It is necessary to ensure uniform cultivation depth to create an even seedbed layer.

The necessary cultivation depth is maintained by the support wheels.



WIDE RANGE OF ADDITIONAL OPTIONS

The FLORIN field cultivator can be equipped according to your needs. For example, clients can choose the appropriate rack option depending on the intended work, weather conditions and field tasks. FLORIN can also be equipped with additional rollers (front chopping and rolling), front cutting discs and a two-row tooth spring harrow.

TECHNICAL DATA

	FLORIN-8
Working width, m; ft	8 /26'
Tractor power, hp.	min 200
Coupling with tractor	semi-trailed
Weight (depending on configuration), kg; lbs	5680-7460/12.522-16.446
Number of tines, pcs.	45
Number of working shares, pcs.	45
Operating depth, cm; inch	3-15/1'-6"
Operating speed, km/h; mph	10-15/6-9
Efficiency, ha/h; acre/h	max 9/22 acre/h
Fuel consumption, l/ha; gal/ac	max 8/0.8
Transport dimensions (length x width x height), mm; inch	10387 x 3494 x 4000 408"x137"x157"





**LOZOVA
MACHINERY**



Stubble cultivation, basic/seedbed preparation



SHILLING

INTENSIVE STUBBLE CULTIVATORS

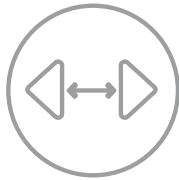

2,24 - 8 m

7'-26' ft



min 80 hp

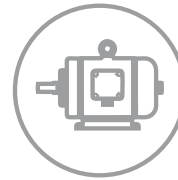

max 2,7 ha/h

max 6,6 acre/h

PERFECT STUBBLE CULTIVATION

The SHILLING intensive stubble cultivators are effectively applied for minimum tillage, which encourages germination and development of crops. SHILLING has the best performance when cultivating the soil before and after grain and legume crops, and widely used for conventional tillage, fallow maintenance and seedbed preparation.

The SHILLING intensive stubble cultivator can be also applied for the intercrops incorporation. Its design provides high-quality mixing of crop residues with soil for the fast decomposition.

The cultivator performs the following operations in one pass:

- soil loosening and crumbling;
- weeds undercutting;
- chopping and incorporating the plant residues, fertilizers for mulching;
- levelling and compaction of the soil;
- seedbed preparation with stable depth.





Rubber support wheels

Demountable support wheels, which height can be adjusted by a screw, provide precise depth control even when using tractors without position control of the mounted system. As an option SHILLING can be equipped with rubber pneumatic wheels.



Optimal position of the center of gravity

Optimal position of the center of gravity is achieved by simple rearrangement of the depth limiter axle and forward displacement of concave discs with roller.

This significantly reduces loads on the tractor coupling and allows cultivator transportation.



Optimal loosening and drainag

Wide wing shares are mounted at a special angle, ensuring undercutting the soil seam over the whole surface and optimal mixing even at shallow depths.

The working width of the share long edgepoints is stable during entire service life.

The SHILLING has advantages over disc implements with rigid tine, such as higher quality of cultivation with precise depth control and levelled seedbed.

Working tools have much smaller soil shoe compared to disc harrows.

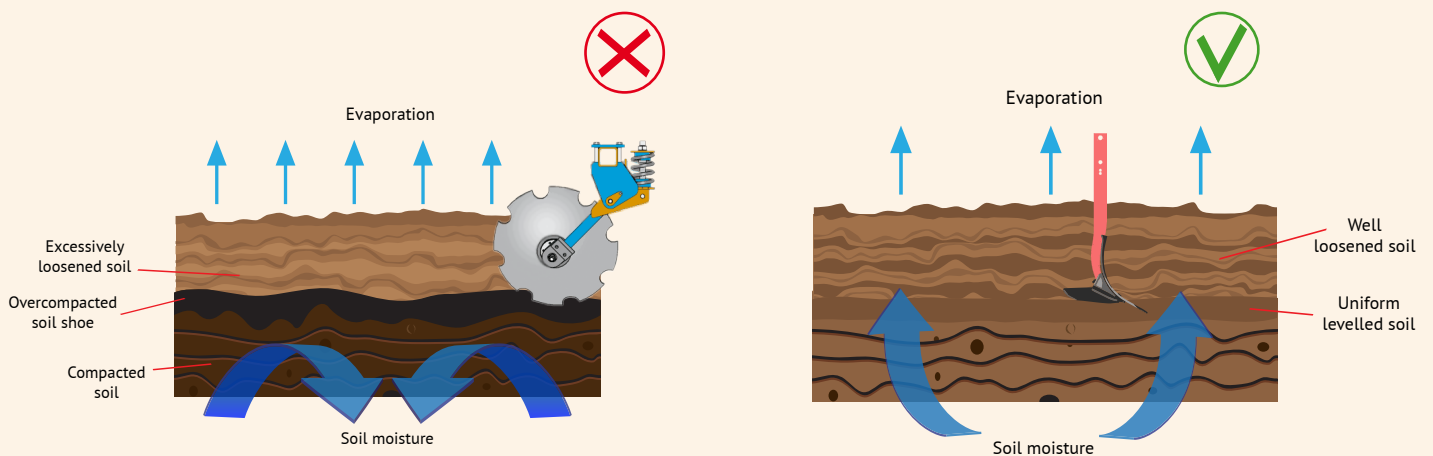

MODULES FOR APPLYING LIQUID FERTILIZERS



The SHILLING can be equipped with an additional HF Agro module for applying basic and starting liquid fertilizers simultaneously with the main operation of the unit.

- 12V power supply from the tractor battery
- tank volume - up to 1000l (at the request of the customer)
- semi-automatic or automatic (optional) system control
- optional control of pouring out on each line



At the request of the client, SHILLING stubble cultivators can be equipped with a module for applying granular fertilizers.

TECHNICAL DATA

	SHILLING-2	SHILLING-3	SHILLING-4	SHILLING-6	THALER+ 2x SHILLING-4
Working width, m; ft	2,24/7'	3,14/7,7'	4,0/9,8'	6,0/15'	8,0/19'
Tractor power, hp	min 80	min 130	min 160	min 300	min 450
Coupling with tractor	mounted	mounted	mounted	mounted	semi-trailed
Basic weight, kg; lbs	748/1.649	1340/2.954	1480/3.262	2906/6.406	5764/12.707
Number of tines, pcs.	5	7	9	13	18
Operating depth, cm; inch	5-22/2"-8"	5-22/2"-8"	5-22/2"-8"	5-22/2"-8"	5-22/2"-8"
Operating speed, km/h; mph	7-12/4-7	7-12/4-7	7-12/4-7	7-12/4-7	7-12/4-7
Efficiency, ha/h; acre/h	до 2,07/5	до 3,01/7	до 3,96/9,7	до 5,84/14	до 7,92/19,5
Fuel consumption, l/ha; gal/ac	6-5/0,6-0,5	6-5/0,6-0,5	6-5/0,6-0,5	6-5/0,6-0,5	6-5/0,6-0,5
Transport dimensions (length x width x height), mm; inch	2613x2508x1450 102"x 98"x 57"	3427x3410x1450 134"x 134"x 57"	2902x4397x1850 114"x 173"x 72"	3554x3024x3900 139"x 119"x 153"	5734x3323x4080 225"x 130"x 160"

Surface tillage



SANTIM

INTER-ROW CULTIVATOR

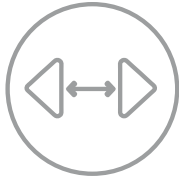

6,4 - 12,4 m
21'-41' ft



min 80 hp



3 - 10 cm
1"-4" in

The inter-row cultivator SANTIM with changeable row spacing from 30 to 75 cm is designed for inter-row cultivation of a wide range of crops: corn, sunflower, soy, sugar beets, peas, beans, etc. Also, the cultivator perfectly works on very wet soil without it sticking on its blades.

One of the options is to equip the cultivator with a high-precision liquid-fertilizer and plant-protection injection system.





Working tools

The working tools include: 32x12 mm spring tines equipped with 150 mm/ 200 mm wide duckfoot shares.

Upon request the unit can be equipped with 250 mm wide shares or 55 mm wide chisel shares.



Spring tine benefits

The spring tine of SANTIM ensures:

- reduction of the draft resistance and fuel consumption by at least 20%;
- uniform cultivation depth due to the prevention of the entire unit deepening when hitting an obstacle;
- self-cleaning of the working tools during the work process, which allows to work effectively on wet soil.



Cultivation depth adjustment

Parallelogram depth maintaining on each row.

Setting of the working depth with an adjustable spindle.



Additional soil loosening

For additional loosening in the middle of the rows or sowing strips, the implement is additionally equipped with sections with a finger-type hoe.

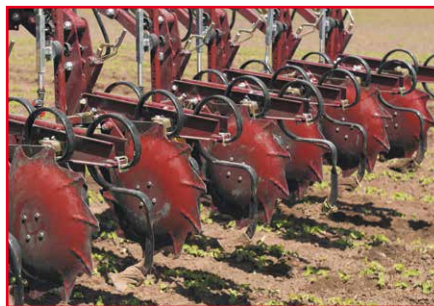

Plants protection from cutting

The automatic adjustment system with iron (or rubber) tracing wheels allows the cultivator to accurately follow the tractor and carry out cultivation very close to the rows without "cutting" the plants.

Protective guards on the bearing support ensure reliable protection of crop plants from cutting (optionally).



Possibility of simultaneous feeding

Optionally, it is possible optionally install HF Agro modules for fertilization on SANTIM row-crop cultivators.

LIQUID FERTILIZER APPLICATION SYSTEM



The HF Agro liquid fertilizer application system is a complex of innovative equipment that makes it possible to purposefully and accurately apply liquid fertilizers directly to the zone of its effective action simultaneously with inter-row cultivation and weed control.

- 12V power supply from the tractor battery
- tank volume - up to 1000l (at the request of the customer)
- semi-automatic or automatic (optional) system control
- optional control of pouring out on each line

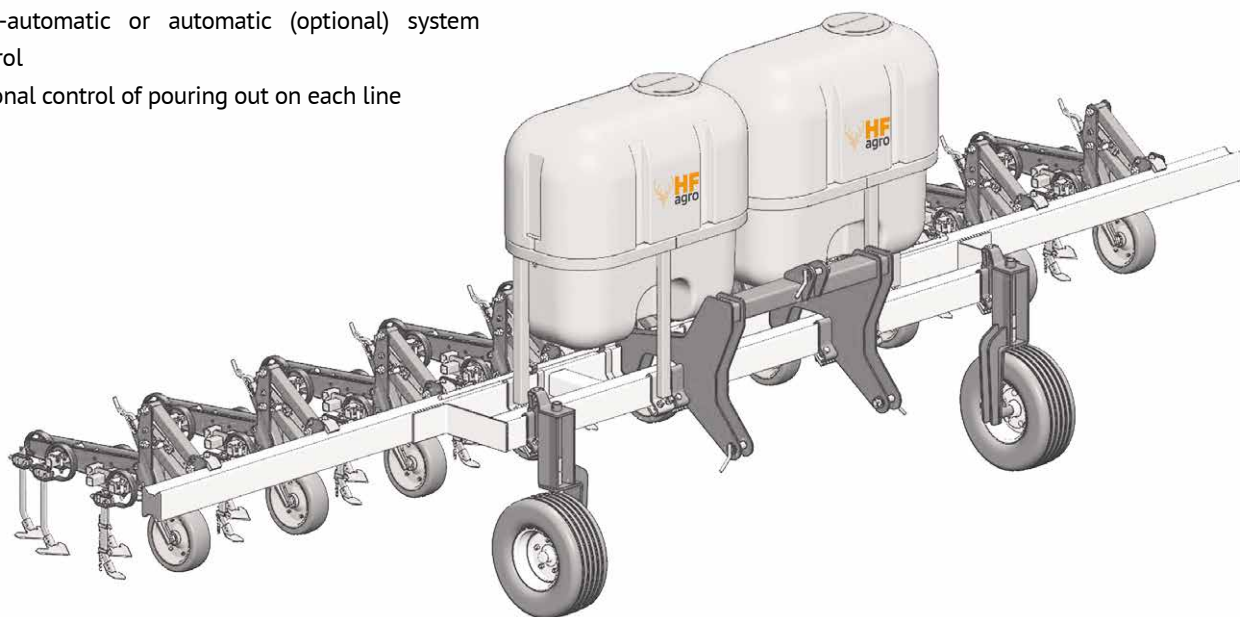

TECHNICAL DATA

	SANTIM-8	SANTIM-12	SANTIM-16
Number of rows to be processed, pcs.	8	12	16
Working width, m; ft	6,4/21'	6,46,4/21'	12,46,4/41'
Tractor power, hp	от 80	от 80	от 120
Coupling with tractor	mounted	mounted	semi-mounted
Working speed, km/h; mph		8-10/5-6	
Weight, kg; lbs	1200/2.645	1550/3.417	4500/9.920
Number of working sections, pcs.	9	13	17
Inter-row distance, cm; inch	70/27"	45/17"	70/27"
Distance from support area to the bottom area, mm; inch		640/25"	
Productivity, ha/h; acre/h	6/2"	6/2"	12/5"
Cultivation depth, cm; inch		3-10/1"-4"	
Ground clearance, mm; inch		min 300/12"	
Overall dimensions in work position (length, width, height), mm; inch	1700 x 3000 x 1800 67"x 118"x 71"	1700 x 3000 x 1800 67"x 118"x 71"	7200 x 3000 x 2400 283"x 118"x 94"

LOZOVA MACHINERY



DUCAT
Compact disc harrows



DUCAT GOLD
Heavy disc harrow



FRANK; GULDEN
Subsoilers



LIRA; LIRA XL
Spring-tooth harrow; Heavy tooth harrow



DINAR
Rotary harrow



CHERVONETS
Seedbed cultivator



FLORIN
Multipurpose field cultivator



SANTIM
Inter-row cultivator



ALBION XL; KELT XXL
Agricultural trailers



HARP



HARP bearings - the best bearings for agricultural machinery with X-SHIELD seals of increased tightness.

HARP AGRO UNIT - solid and maintenance-free bearing units (repairable) optimized for agricultural machinery.

4, Marshal Batitskiy Str.
Kharkov, 61038, Ukraine
+38 (057) 766-00-61
+38 (057) 766-00-62
agro@lozovamachinery.com

Join us in
social networks



lozovamachinery.com